

SPECIFICATIONS

| | |
|-----------------------|--|
| Electrical Ratings | 3A @ 120VAC, 28VDC; 1A @ 250VAC See Contact Options |
| Electrical Life | 30,000 cycles typical |
| Contact Resistance | < 20 mΩ max initial @ 2-4VDC, 100mA |
| Dielectric Strength | 1500Vrms min |
| Insulation Resistance | > 100MΩ min |
| Operating Temperature | -40°C to 85°C |
| Storage Temperature | -40°C to 85°C |



UL US - E222871







MATERIALS ←RoHS COMPLIANT



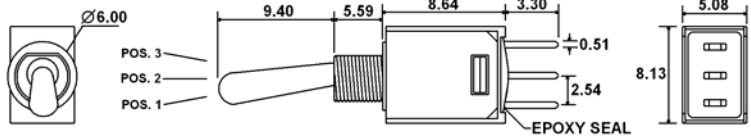

| | |
|-----------|-------------------------------------|
| Actuator | Brass, Chrome Plated |
| Housing | DAP – Diallyl Phthalate |
| Cover | Stainless Steel |
| Bushing | Brass, Nickel Plated |
| Contacts | Copper Alloy, Silver or Gold Plated |
| Terminals | Brass, Silver or Gold Plated |

ORDERING INFORMATION

| | | | | | | | | |
|---|------------|----------|----------|----------|-----------|----------|----------|----------|
| Series: | BNT | 2 | 1 | U | E1 | C | Q | E |
| BNT | | | | | | | | |
| Number of Poles: | | | | | | | | |
| 1 = SPDT | | | | | | | | |
| 2 = DPDT | | | | | | | | |
| Switch Function: | | | | | | | | |
| 1 = ON-NONE-ON | | | | | | | | |
| 2 = ON-NONE-(ON) | | | | | | | | |
| 3 = ON-OFF-ON | | | | | | | | |
| 4 = (ON)-OFF-(ON) ** Only available in SPDT | | | | | | | | |
| 5 = ON-OFF-(ON) ** Only available in SPDT | | | | | | | | |
| 6 = ON-ON-ON ** See Three Way Wiring Section for Details | | | | | | | | |
| Actuator: | | | | | | | | |
| T = 5.33mm, Std, available on E/E1/F/F1 Bushings | | | | | | | | |
| U = 7.37mm, Std, available on E/E1/F/F1 Bushings | | | | | | | | |
| S = 9.40mm, Std, available on E/E1/F/F1 Bushings | | | | | | | | |
| X = 5.59mm, Std, available on G/G1/J/J1 Bushings | | | | | | | | |
| V = 10.41mm, Std, available on G/G1/J/J1 Bushings | | | | | | | | |
| Bushing: | | | | | | | | |
| E / E1 = 5.59mm, 10-48UNS / Non-Threaded, Flat | | | | | | | | |
| F / F1 = 5.59mm, 10-48UNS / Non-Threaded, Keyway | | | | | | | | |
| J / J1 = 6.60mm, ¼-40NS / Non-Threaded, Keyway | | | | | | | | |
| G / G1 = 7.87mm, ¼-40NS / Non-Threaded, Flat | | | | | | | | |
| Terminals: | | | | | | | | |
| B = Solder Lug | | | | | | | | |
| C = PC Pin | | | | | | | | |
| H = Horizontal Mount, Right Angle PC Pin; HS = Snap-in | | | | | | | | |
| V = Vertical Mount, Right Angle PC Pin; VS = Snap-in | | | | | | | | |
| A5 = PC Pin with Support Bracket; A5S = Snap-in Support Bracket | | | | | | | | |
| Contacts: | | | | | | | | |
| Q = Silver Plated | | | | | | | | |
| R = Gold Plated | | | | | | | | |
| G = Gold over Silver Plated | | | | | | | | |
| Epoxy Seal: | | | | | | | | |
| E = Epoxy Seal | | | | | | | | |

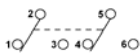
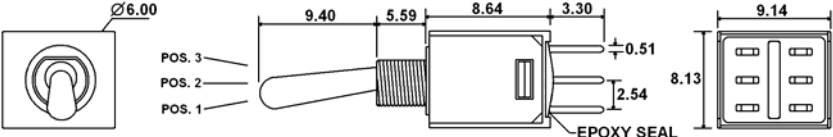
SWITCH FUNCTION

| | | | | | |
|---|----------|---|---|---|--|
|  SPDT  | Function | Toggle Position | | |  |
| | |  |  |  | |
| | 1 | ON | NONE | ON | |
| | 2 | ON | NONE | (ON) | |
| | 3 | ON | OFF | ON | |
| 4 | (ON) | OFF | (ON) | | |
| 5 | ON | OFF | (ON) | | |
| Terminals | 2-3 | --- | 2-1 | | |

| | | | | | |
|---|------------|---|---|---|--|
|  DPDT  | Function | Toggle Position | | |  |
| | |  |  |  | |
| | 1 | ON | NONE | ON | |
| | 2 | ON | NONE | (ON) | |
| | 3 | ON | OFF | ON | |
| Terminals | 2-3 5-6 | --- | 2-1 5-4 | | |
| 6 | ON | ON | ON | | |
| Terminals | 2-3 5-6 | 2-3 5-4 | 2-1 5-4 | | |

ACTUATOR OPTIONS

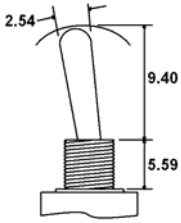
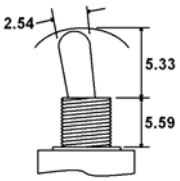
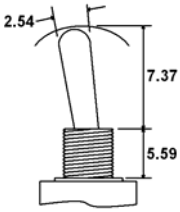
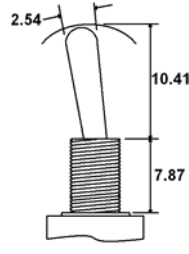
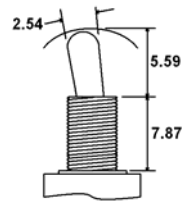
| | | | | |
|---|---|---|--|---|
|  S |  T |  U |  V |  X |
|---|---|---|--|---|

**Only available with E, E1, F, & F1 Bushings

**Only available with G, G1, J, & J1 Bushings

BUSHING OPTIONS

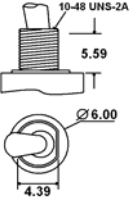
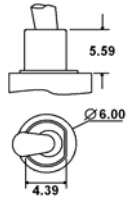
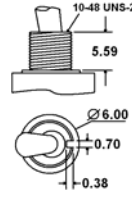
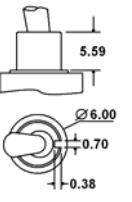
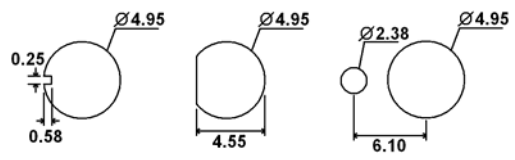
| | | | | |
|---|--|---|--|--|
|  E |  E1 |  F |  F1 |  |
| | | | | Panel Mounting – 10-48 |

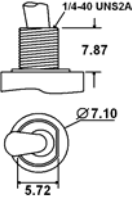
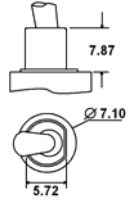
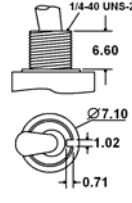
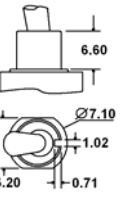
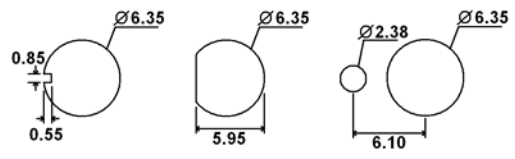
| | | | | |
|---|--|---|--|--|
|  G |  G1 |  J |  J1 |  |
| | | | | Panel Mounting – 1/4-40 |

TERMINAL OPTIONS

| | | | |
|-----------------|-----------------|-----------------|-----------------|
| | | | |
| B – SPDT | B – DPDT | C – SPDT | C – DPDT |

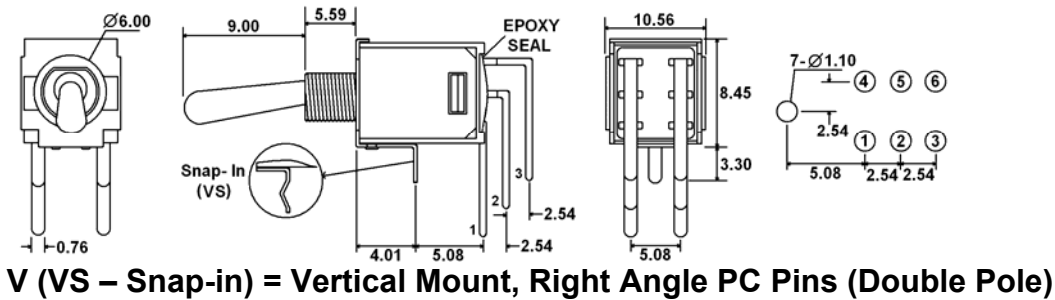
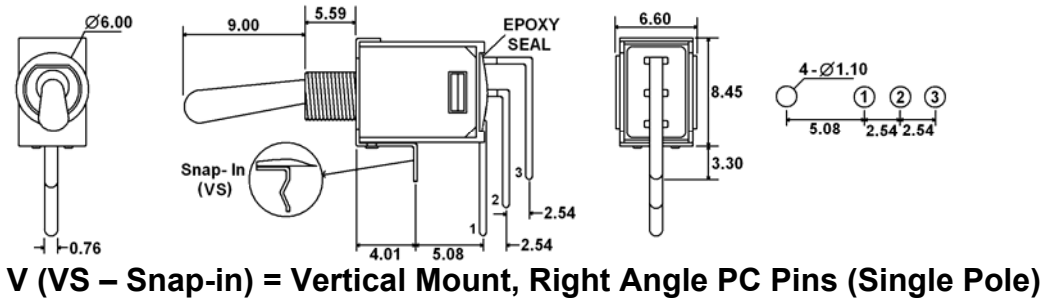
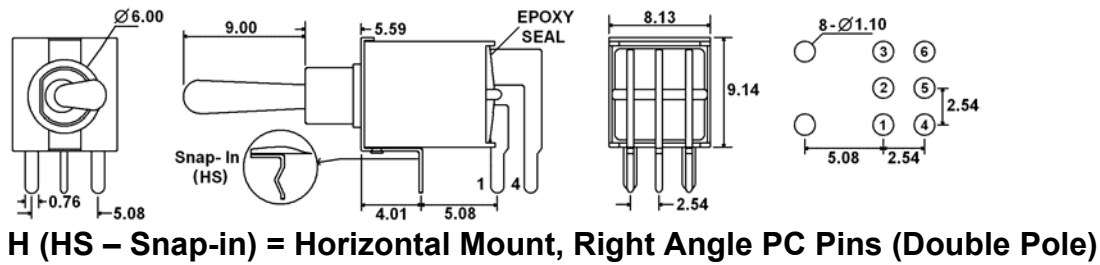
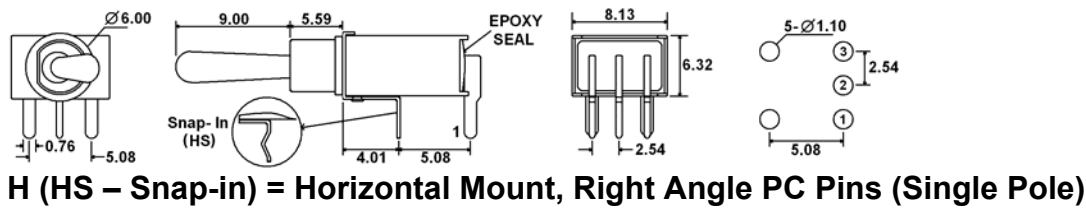

TERMINAL OPTIONS

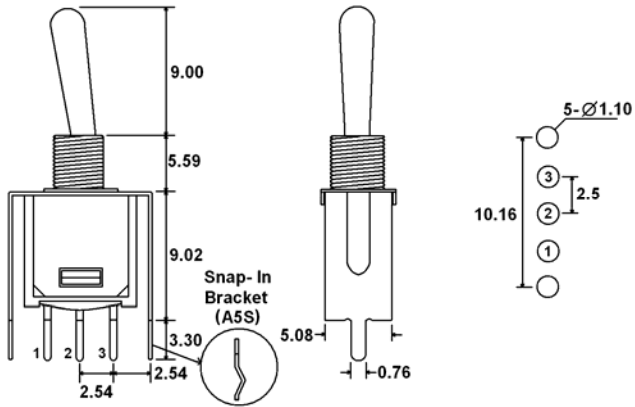

**A5 (A5S – Snap-in Bracket)
PC Pins with Support Bracket (Single Pole)**

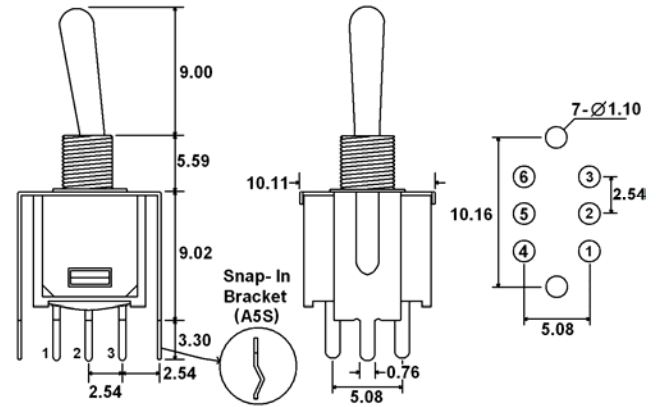

**A5 (A5S – Snap-in Bracket)
PC Pins with Support Bracket (Double Pole)**

CONTACT OPTIONS

| Designator | Contact Material | Terminal Material | Electrical Ratings |
|------------|--------------------------|--------------------------|---|
| Q | Silver Plating | Silver Plating | 3A @ 120VAC, 28VDC; 1A @ 250VAC |
| R | Gold over Nickel Plating | Gold over Nickel Plating | .4 VA max @ 20VAC or VDC max |
| G | Gold over Silver Plating | Gold over Silver Plating | .4 VA max @ 20VAC or VDC max or 3A @ 120VAC, 28VDC; 1A @ 250VAC |

THREE WAY WIRING DIAGRAM

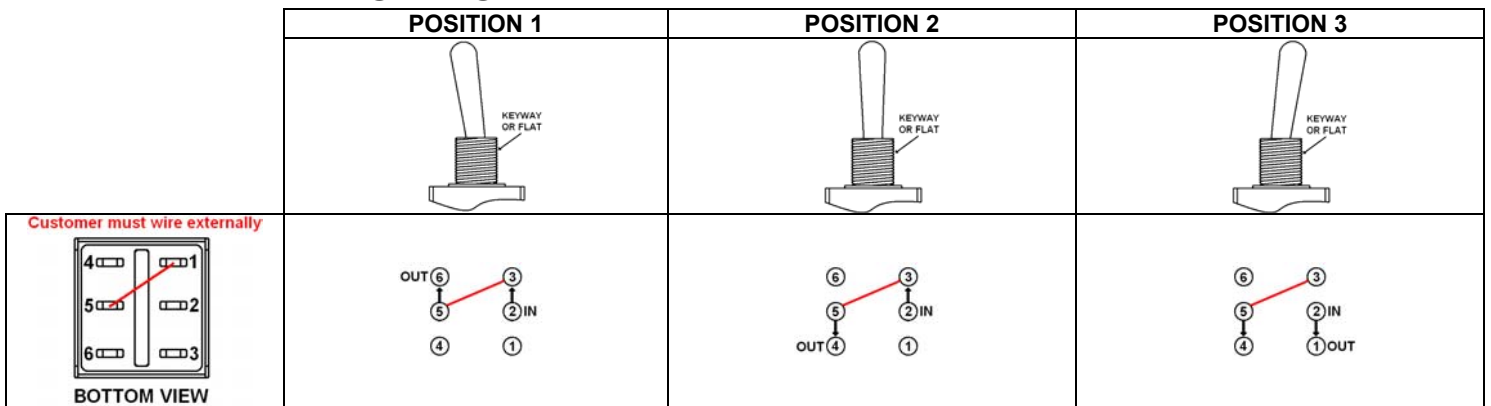

HARDWARE **Two hex nuts, one lock washer, & one locking ring supplied standard with threaded bushings

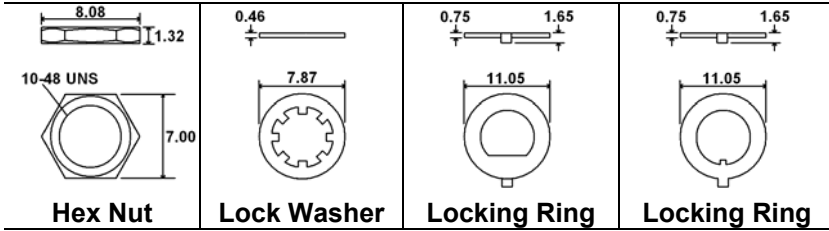

**For use with E & F Bushings

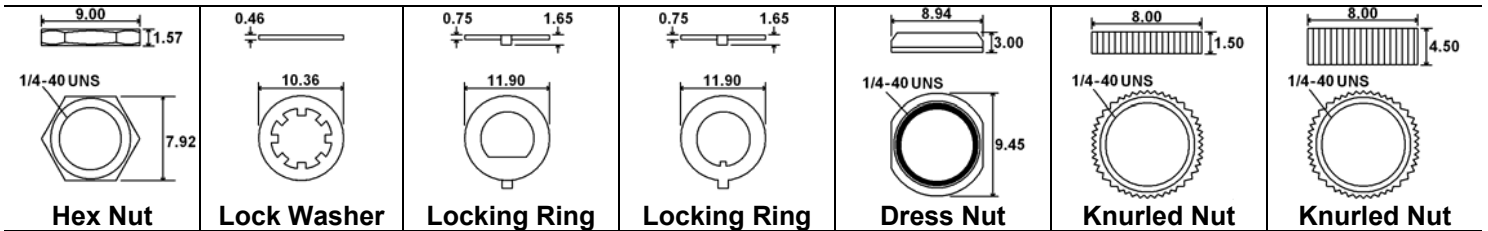

**For use with G & J Bushings